

NUBIA

design DEBONADEMEO STUDIO



Un connubio di forme e funzioni. Il senso del relax può scaturire dal semplice sguardo rivolto all'oggetto dei desideri. Una collezione di sedute che invitano alla quiete per le loro forme sinuose e per la loro organicità. Le componenti appaiono connesse senza forzature meccaniche, semplicemente appoggiate le une alle altre, come petali in movimento.

A combination of form and function. Relaxation can come from simply looking at the object of your desire. A series of armchairs that invite you to rest with their sinuous shapes and organicity. The components seem to be holding on to each other without mechanical force, like flower petals in motion.

NUBIA

design DEBONADEMEO STUDIO

SBOG48



SBOB01



BOB114



BOG48



Sedia / Chair



NUBIA

design DEBONADEMEO STUDIO

SENZA BRACCIOLI / WITHOUT ARMRESTS SBOG48

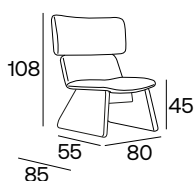

80 cm / 31.50"
85 cm / 33.46"
108 cm / 42.52"
45 cm / 17.72"
55 cm / 21.65"

22 kg / 49 Lb

0.82 m³

5.50 mtl
tessuto cliente /
customer fabric
H 140 cm

10.23 mtl
pelle cliente /
customer leather



1 - 2.00 mtl
2 - 1.00 mtl
4 - 2.00 mtl

SBOG49

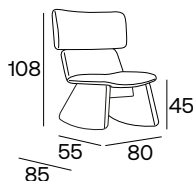

80 cm / 31.50"
85 cm / 33.46"
108 cm / 42.52"
45 cm / 17.72"
55 cm / 21.65"

22 kg / 49 Lb

0.82 m³

5.50 mtl
tessuto cliente /
customer fabric
H 140 cm

10.23 mtl
pelle cliente /
customer leather



1 - 2.00 mtl
2 - 1.00 mtl
4 - 2.00 mtl

SBOB01

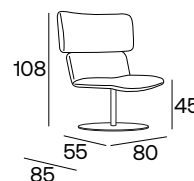

80 cm / 31.50"
85 cm / 33.46"
108 cm / 42.52"
45 cm / 17.72"
55 cm / 21.65"

28 kg / 61 Lb

0.82 m³

5.00 mtl
tessuto cliente /
customer fabric
H 140 cm

9.30 mtl
pelle cliente /
customer leather



1 - 2.00 mtl
2 - 1.00 mtl

SBOB08

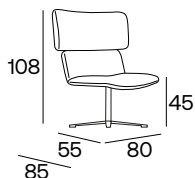

80 cm / 31.50"
85 cm / 33.46"
108 cm / 42.52"
45 cm / 17.72"
55 cm / 21.65"

28 kg / 62 Lb

0.82 m³

5.00 mtl
tessuto cliente /
customer fabric
H 140 cm

9.30 mtl
pelle cliente /
customer leather



1 - 2.00 mtl
2 - 1.00 mtl

SBOG50

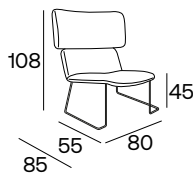

80 cm / 31.50"
85 cm / 33.46"
108 cm / 42.52"
45 cm / 17.72"
55 cm / 21.65"

20 kg / 45 Lb

0.82 m³

5.00 mtl
tessuto cliente /
customer fabric
H 140 cm

9.30 mtl
pelle cliente /
customer leather



1 - 2.00 mtl
2 - 1.00 mtl

CON BRACCIOLI / WITH ARMRESTS BOG48

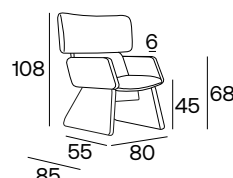

80 cm / 31.50"
85 cm / 33.46"
108 cm / 42.52"
45 cm / 17.72"
55 cm / 21.65"
68 cm / 25.98"
6 cm / 2.36"

22 kg / 49 Lb

0.82 m³

6.00 mtl
tessuto cliente /
customer fabric
H 140 cm

11.16 mtl
pelle cliente /
customer leather



1 - 2.00 mtl
2 - 1.00 mtl
4 - 2.00 mtl

BOG49

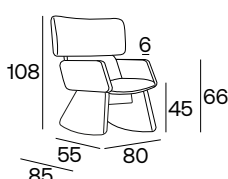

80 cm / 31.50"
85 cm / 33.46"
108 cm / 42.52"
45 cm / 17.72"
55 cm / 21.65"
68 cm / 25.98"
6 cm / 2.36"

22 kg / 49 Lb

0.82 m³

6.00 mtl
tessuto cliente /
customer fabric
H 140 cm

11.16 mtl
pelle cliente /
customer leather



1 - 2.00 mtl
2 - 1.00 mtl
4 - 2.00 mtl

BOB01

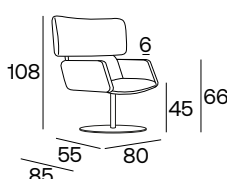

80 cm / 31.50"
85 cm / 33.46"
108 cm / 42.52"
45 cm / 17.72"
55 cm / 21.65"
68 cm / 25.98"
6 cm / 2.36"

28 kg / 62 Lb

0.82 m³

5.50 mtl
tessuto cliente /
customer fabric
H 140 cm

10.23 mtl
pelle cliente /
customer leather

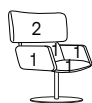

1 - 4.50 mtl
2 - 1.00 mtl

BOB08

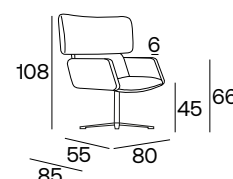

80 cm / 31.50"
85 cm / 33.46"
108 cm / 42.52"
45 cm / 17.72"
55 cm / 21.65"
68 cm / 25.98"
6 cm / 2.36"

28 kg / 62 Lb

0.82 m³

5.50 mtl
tessuto cliente /
customer fabric
H 140 cm

10.23 mtl
pelle cliente /
customer leather

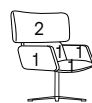

1 - 4.50 mtl
2 - 1.00 mtl

NUBIA

design DEBONADEMEO STUDIO

BOG50

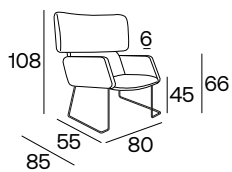

80 cm / 31.50"
85 cm / 33.46"
108 cm / 42.52"
45 cm / 17.72"
55 cm / 21.65"
68 cm / 25.98"
6 cm / 2.36"

 20 kg / 45 Lb

 0.82 m³

 **5.50 mtl**
tessuto cliente /
customer fabric
H 140 cm

10.23 mtl
pelle cliente /
customer leather



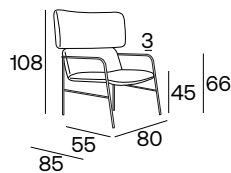

1 - 4.50 mtl
2 - 1.00 mtl

BOB114



80 cm / 31.50"
85 cm / 33.46"
108 cm / 42.52"
45 cm / 17.72"
55 cm / 21.65"
68 cm / 25.98"
3 cm / 1.18"

 22 kg / 49 Lb

 0.82 m³

 **5.00 mtl**
tessuto cliente /
customer fabric
H 140 cm

9.30 mtl
pelle cliente /
customer leather



1 - 4.50 mtl
2 - 1.00 mtl

SEDIA / CHAIR

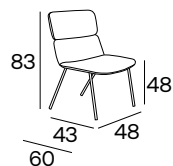

48 cm / 18.90"
60 cm / 23.62"
83 cm / 32.68"
48 cm / 18.90"
43 cm / 16.93"

 28 kg / 67 Lb

 0.28 m³

 **1.50 mtl**
tessuto cliente /
customer fabric
H 140 cm

2.79 mtl
pelle cliente /
customer leather

NUBIA

design DEBONADEMEO STUDIO

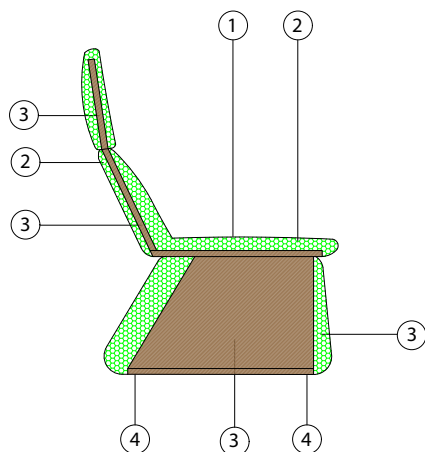

POLTRONE / ARMCHAIRS

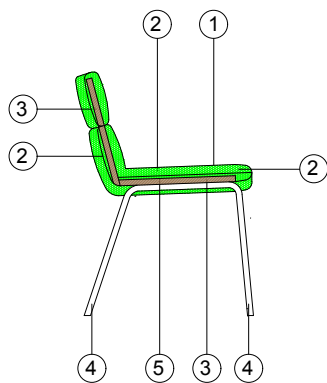

SEDIA / CHAIR

MATERIALI / MATERIALS

- 1 - tessuto/pelle
 - 2 - poliuretano espanso indeformabile di diverse densità e strato di fibra di dacron® 100 gr
 - 3 - telaio in multistrato di legno di abete
 - 4 - gamba tappezzata G 48 / slitta G 49 / base B 01 / base B 08 / slitta G 50 / base B 114 / base B 117
-
- 1 - fabric/leather
 - 2 - high resilience polyurethane foam of different densities and dacron® fiber 100 gr layer
 - 3 - structural frame in plywood
 - 4 - legs G 48 / sled G 49 / base B 01 / base B 08 / sled G 50 / base B 114 / base B 117

PIEDI / FEET



G 48 h 36 cm
Gambe tappezzate
Upholstered legs



B 01 h 36 cm
Base girevole con piatto circolare in metallo verniciato
Swivel circular varnished base



G 50 h 41 cm
Slitta a tubolare metallico verniciato a sezione circolare
Varnished metal circular tubular sled



B 117 Ø 3 cm h 61 cm
Base tubolare metallico verniciato
Metal varnished tubular base



G 49 h 36 cm
Slitta a dondolo rivestita
Upholstered rocking sled



B 08 h 41 cm
Base girevole con razze in metallo verniciato
Swivel spoke varnished base



B 114 Ø 3 cm h 61 cm
Base tubolare metallico verniciato a sezione circolare
Metal varnished circular tubular base



RAL - NCS a scelta
RAL - NCS on request

CARATTERISTICHE / TECHNICAL FEATURES

SFODERABILITÀ / COVER REMOVAL



VARIANTI / VERSIONS



NUBIA

design DEBONADEMEO STUDIO

RIVESTIMENTI CONSIGLIATI / SUGGESTED FABRICS

JAGUARD	BIELASTICO / BIELASTIC	LANA / WOOL	TESS. SPALMATO / COATED FABRIC	VELLUTO / VELVET	MICROFIBRA/ MICROFIBER	BOUCLÈ	PELLE / LEATHER
CHILI Cat. extra	MIRAGE Cat. lusso	EUROPOST 2 Cat. elegant	VINTAGE Cat. extra	LEMMING 29500 Cat. elegant	MYSTIQUE Cat. extra	VOLT Cat. super	MOON Cat. extreme
MINI MELANGE Cat. lusso	NAUTILUS Cat. extra	FENICE Cat. extra	FLEXO FR Cat. a	8336/8336 LT Cat. lusso/extra			FLOWER Cat. elegant
OCEANIC Cat. elegant	UNIFORM MELANGE Cat. plus	HERO 2 Cat. extreme	ZEUS Cat. a	CINIGLIA / CHENILLE			BASIC Cat. elegant
ONE Cat. a				AMARA 83974 Cat. elegant			OLD Cat. top
PANAREA OUTDOOR Cat. a							LUX Cat. top
RADIO Cat. a							RÈTRO Cat. extreme
STEELCUT TRIO 3 Cat. top							NABUK Cat. plus
STEP Cat. extra							
SUMMER/SUMMER FR Cat. a							