

# NEFELIBATA

design STORMO STUDIO



NEFELIBATA, un viandante tra le nuvole, libero dai limiti del mondo terreno. La sua essenza, catturata in questa collezione, si distacca dalle rigide convenzioni del concetto di divano, invitando a sognare e a perdersi nelle sue forme sinuose. NEFELIBATA si allunga e si curva, plasmando il proprio corso con la stessa leggerezza dei pensieri liberi di coloro che sognano ad occhi aperti.

NEFELIBATA is a traveller in the clouds, unfettered by the constraints of the earthly world. Its essence, captured in this series, breaks away from the rigid conventions of the sofa concept and invites you to dream in the flow of its sinuous forms. NEFELIBATA stretches and curves, shaping its own course as light and carefree as the thoughts of those who daydream.

NEFELIBATA  
design STORMO STUDIO



# NEFELIBATA

design STORMO STUDIO

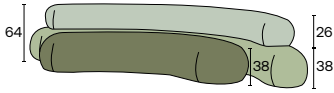

## POUF / POUFS

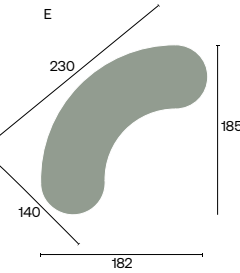
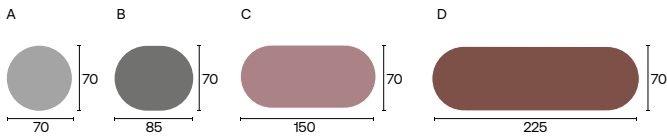

## TAVOLINO / SMALL TABLE

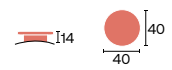

## SVILUPPO CUSTOM / CUSTOM LENGTH

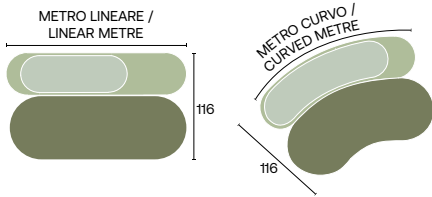

Lo schienale è composto da due elementi, base e poggiatesta, disponibili entrambi in lunghezza custom. Il poggiatesta può avere dimensione uguale o inferiore alla base. Se più larga del poggiatesta, la base può fungere da seduta, ospitare prese di ricarica e un tavolino.

The backrest consists of two components—a base and a lumbar support—both of which are available in custom lengths. The lumbar support can be the same width as or narrower than the base. If the base is wider than the lumbar support, it can serve as a seat and accommodate charging ports and a small table.

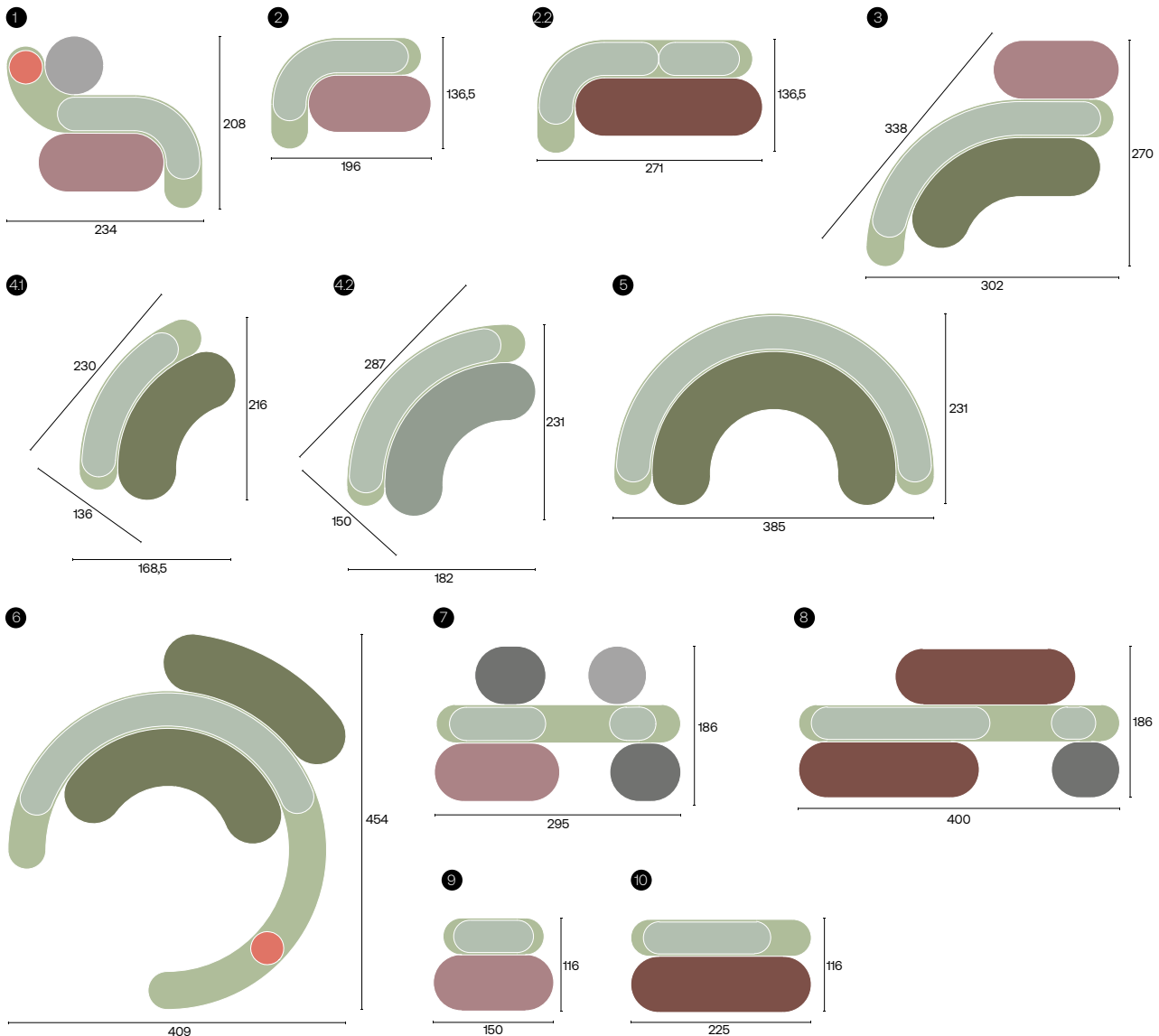

# NEFELIBATA

design STORMO STUDIO

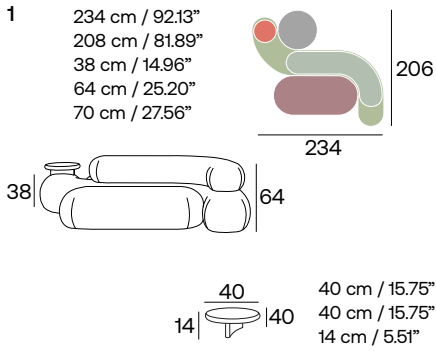

70 kg / 155 Lb

X 3 0.48 m<sup>3</sup> x 1 - 2.24 m<sup>3</sup> x 1 - 0.40 m<sup>3</sup> x 1

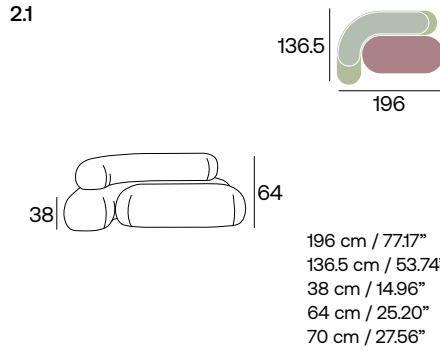
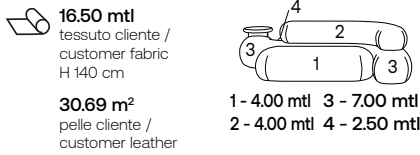

53 kg / 117 Lb

X 1 1.91 m<sup>3</sup>

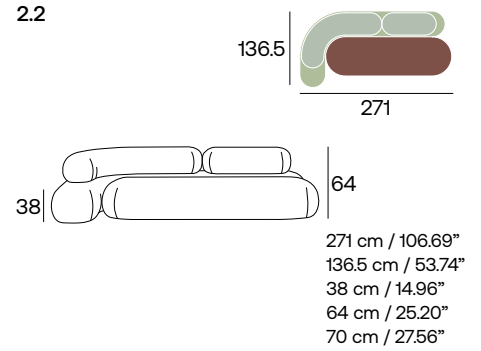

70 kg / 155 Lb

X 1 2.75 m<sup>3</sup>

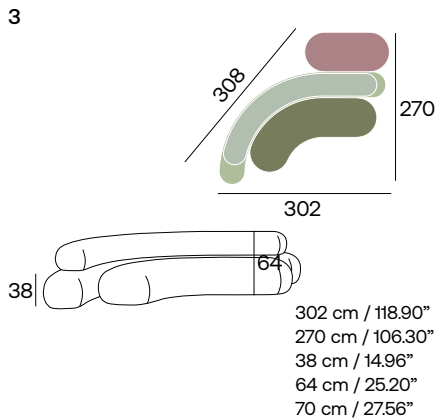
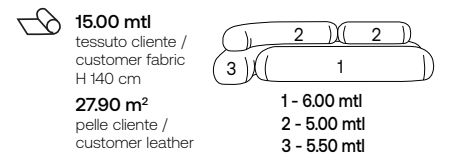

100 kg / 221 Lb

X 2 2.92 m<sup>3</sup> x 1 - 2.05 m<sup>3</sup> x 1

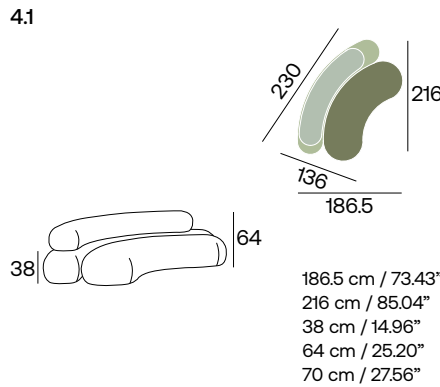
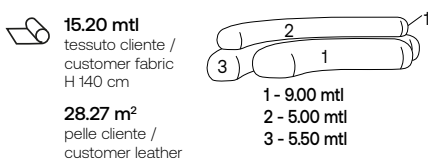

58 kg / 128 Lb

X 1 2.35 m<sup>3</sup>

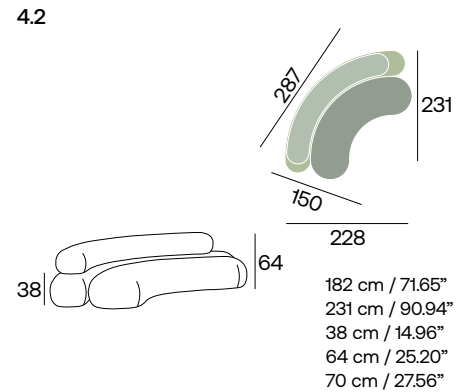

60 kg / 133 Lb

X 1 3.19 m<sup>3</sup>

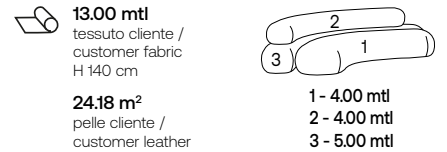

# NEFELIBATA

design STORMO STUDIO

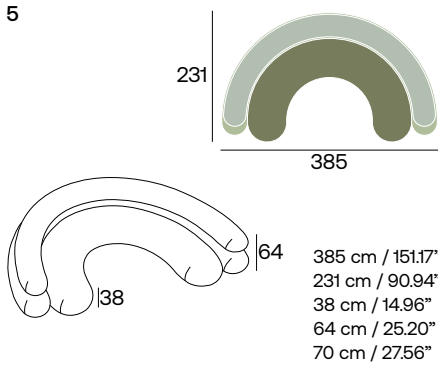

127 kg / 280 Lb

X 2 2.08 m³ x 1 - 2.48 m³ x 1

22.70 mtl  
tessuto cliente /  
customer fabric  
H 140 cm

42.22 m²  
pelle cliente /  
customer leather

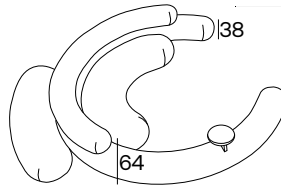
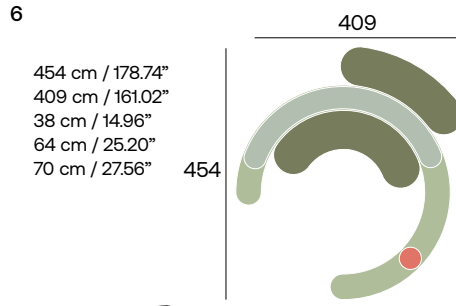
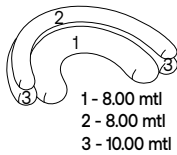

140 kg / 309 Lb

X 3 3.99 m³ x 1 - 2.45 m³ x 1 - 1.55 m³ x 1

26.70 mtl  
tessuto cliente /  
customer fabric  
H 140 cm

49.66 m²  
pelle cliente /  
customer leather

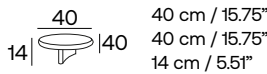

1 - 12.00 mtl  
2 - 5.00 mtl  
3 - 9.50 mtl

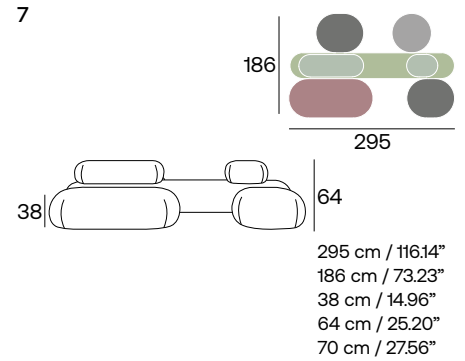

73 kg / 161 Lb

X 4 0.28 m³ x 1 - 0.48 m³ x 1 -  
0.23 m³ x 1 - 1.02 m³ x 1

16.40 mtl  
tessuto cliente /  
customer fabric  
H 140 cm

30.50 m²  
pelle cliente /  
customer leather

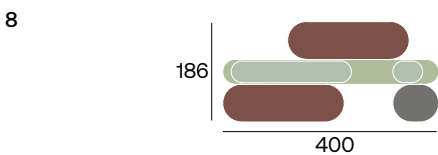
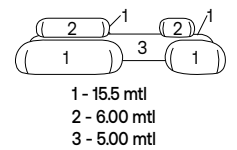

80 kg / 177 Lb

X 4 1.36 m³ x 2 - 0.27 m³ x 1 -  
1.40 m³ x 1

19.00 mtl  
tessuto cliente /  
customer fabric  
H 140 cm

35.34 m²  
pelle cliente /  
customer leather

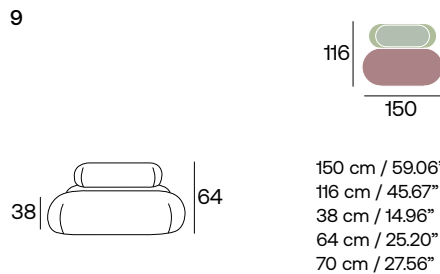
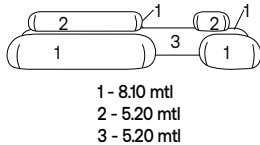

18 kg / 40 Lb

1.26 m³

8.40 mtl  
tessuto cliente /  
customer fabric  
H 140 cm

15.62 m²  
pelle cliente /  
customer leather

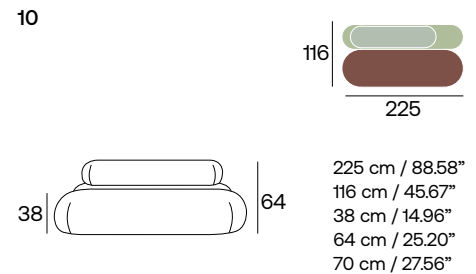
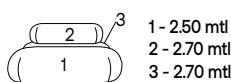

28 kg / 62 Lb

1.87 m³

10.60 mtl  
tessuto cliente /  
customer fabric  
H 140 cm

19.72 m²  
pelle cliente /  
customer leather

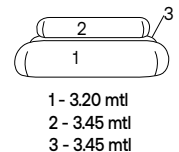

# NEFELIBATA

design STORMO STUDIO

## SEDUTE / SEATINGS

**A**



70 |  | 70

38 | 

70 cm / 27.56"  
70 cm / 27.56"  
38 cm / 14.96"

 7 kg / 16 Lb

 0.22 m<sup>3</sup>

 **1.80 mtl**  
tessuto cliente /  
customer fabric  
H 140 cm

**3.72 m<sup>2</sup>**  
pelle cliente /  
customer leather

**B**



70 |  | 85

38 | 

85 cm / 33.46"  
70 cm / 27.56"  
38 cm / 14.96"

 7.5 kg / 17 Lb

 0.27 m<sup>3</sup>

 **2.00 mtl**  
tessuto cliente /  
customer fabric  
H 140 cm

**3.72 m<sup>2</sup>**  
pelle cliente /  
customer leather

**C**



70 |  | 150

38 | 

150 cm / 59.06"  
70 cm / 27.56"  
38 cm / 14.96"

 10.5 kg / 24 Lb

 0.46 m<sup>3</sup>

 **2.80 mtl**  
tessuto cliente /  
customer fabric  
H 140 cm

**5.21 m<sup>2</sup>**  
pelle cliente /  
customer leather

**D**





70 |  | 225

38 | 

225 cm / 88.58"  
70 cm / 27.56"  
38 cm / 14.96"

 14 kg / 31 Lb

 0.63 m<sup>3</sup>

 **3.70 mtl**  
tessuto cliente /  
customer fabric  
H 140 cm

**6.88 m<sup>2</sup>**  
pelle cliente /  
customer leather

**E**



38 | 



230  
104  
70

230 cm / 90.55"  
104 cm / 40.94"  
38 cm / 14.96"  
70 cm / 29.53"

 12 kg / 27 Lb

 1.03 m<sup>3</sup>

 **4.00 mtl**  
tessuto cliente /  
customer fabric  
H 140 cm

**6.51 m<sup>2</sup>**  
pelle cliente /  
customer leather

## L TAVOLINO / L SMALL TABLE

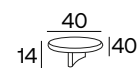

 1.5 kg / 4 Lb

40 cm / 15.75"  
40 cm / 15.75"  
14 cm / 5.51"

# NEFELIBATA

design STORMO STUDIO

## PROGETTA IL TUO NEFELIBATA / DESIGN YOUR NEFELIBATA

Nefelibata ti lascia piena libertà di progettare lunghezze, proporzioni e volumi, sia nella versione lineare che curva. Allinea, sfalsa, fai avanzare o arretrare gli elementi per creare pieni, vuoti e configurazioni sempre diverse. Decidi la lunghezza di ogni componente — seduta, base schienale e schienale poggiaeni — per dare forma a composizioni dinamiche e perfettamente integrate nel progetto.

Nefelibata gives you complete freedom to design lengths, proportions, and volumes, whether in the linear or curved version. Align, stagger, or move elements forward or backward to create solid and open spaces and ever-changing configurations. Determine the length of each component—seat, base, and lumbar support—to create dynamic compositions that integrate seamlessly into the design.

### TAVOLINO SMALL TABLE

Un pratico piano di appoggio realizzato in metallo e piano in MDF laccato.

A practical desk or shelf for small objects. Made of metal and lacquered MDF.

### SCHIENALE POGGIARENI RELAXING BACKREST

Un morbido supporto, accogliente e rilassante. Lo schienale poggiaeni offre libertà progettuale, può essere sviluppato nella stessa dimensione della base, oppure in dimensione ridotta e può essere spezzato in più blocchi. Ha un aggancio fisso, non è un elemento mobile.

A soft comfortable and relaxing backrest. It can feature the same size as the base or a smaller size and can be divided into several blocks. It has a fixed attachment, it is not a moving element.

### SEDUTA SEAT

Parola d'ordine: comfort. Le densità differenziate dell'imbottitura e la sua forma che sembra plasmata con la plastilina rendono la permanenza sul divano un'esperienza rilassante, indipendentemente dall'uso, che sia a scopo ricreativo o semplicemente un'attesa. Comfort is the keyword of this series. The various density of the padding and its rounded shape make sitting on this sofa a relaxing experience, whether you're enjoying a break and loosening up or just waiting around.

### BASE SCHIENALE BACKREST BASE

La base dello schienale è un elemento a libera dimensione, che se lasciato fuoriuscire dallo schienale poggiaeni si trasforma in una comoda seduta. Vi si possono posizionare prese di ricarica e un pratico tavolino.

The base of the backrest is an element whose dimensions can be customized. When larger than the backrest, it becomes a comfortable seat. Charging sockets and a practical table can be placed there.

### PRESE SOCKETS



Preso elettrica schuko.  
Schuko socket.





Due prese elettriche USB.  
Two USB sockets.

# NEFELIBATA

design STORMO STUDIO

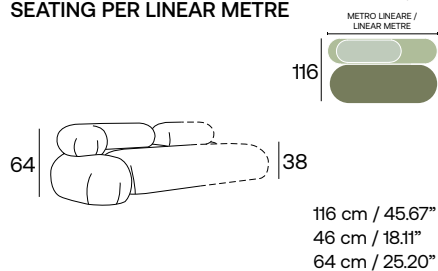
## DIVANO AL METRO LINEARE / SEATING PER LINEAR METRE



 26 kg / 58 Lb

 0.34 m<sup>3</sup>

 4.90 mtl  
tessuto cliente /  
customer fabric  
H 140 cm

9.11 m<sup>2</sup>  
pelle cliente /  
customer leather

## DIVANO AL METRO CURVO / SEATING PER CURVED METRE

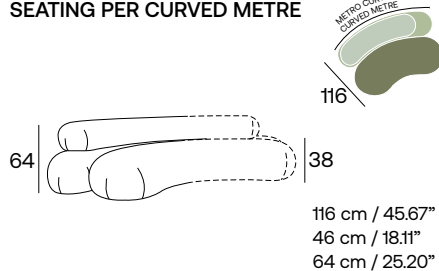

 26 kg / 58 Lb

 0.34 m<sup>3</sup>

 4.90 mtl  
tessuto cliente /  
customer fabric  
H 140 cm

9.11 m<sup>2</sup>  
pelle cliente /  
customer leather

# NEFELIBATA

design STORMO STUDIO

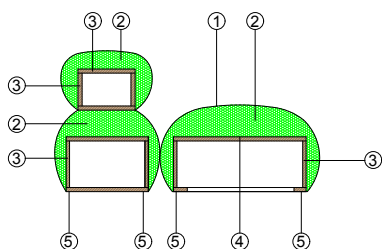

## MATERIALI / MATERIALS

- 1 - tessuto/pelle
- 2 - poliuretano espanso indeformabile densità variabili e strato di fibra di dacron® 100 gr
- 3 - telaio in multistrato di legno
- 4 - piedi a scomparsa in metallo
- 5 - cinghie elastiche intrecciate

- 1 - fabric/leather
- 2 - high resilience polyurethane foam var. densities and dacron® fiber 100 gr layer
- 3 - structural frame in plywood
- 4 - metal hidden feet
- 5 - elastic webbing

## TAVOLINO METALLO-LEGNO / METAL-WOODEN SMALL TABLE

DI SERIE / INCLUDED



RAL - NCS a scelta  
RAL - NCS on request

OPTIONAL / EXTRA COST



Rosa  
fluorescente /  
Flourescent  
pink  
RAL 7014



Arancio  
fluorescente /  
Flourescent  
orange  
RAL 2005



Giallo  
fluorescente /  
Flourescent  
yellow  
RAL 1026



Blu  
fluorescente /  
Flourescent  
blue  
RAL 5012



Verde  
fluorescente /  
Flourescent  
green  
RAL 6038

## CARATTERISTICHE / TECHNICAL FEATURES

SFODERABILITÀ /  
COVER REMOVAL



VARIANTI / VERSIONS



PRESE / CHARGING PORTS



## PRESE / CHARGING PORTS

Prese USB integrabili nel divano per la ricarica di dispositivi elettronici. Accessorio opzionale disponibile con supplemento.

USB ports can be integrated into the sofa for charging electronic charging ports. Optional accessory available at extra cost.

PICK-USB 



USB 2xA

Ø 4.2 cm  
Alimentazione 110-240 Vac 50/60 Hz.  
È disponibile in due materiali: in plastica nero opaco, bianco opaco e argento e in zama metallo acciaio spazzolato, bronzo, champagne, peltro, oro satinato, nero satinato, Ral 9003 e Ral 9010.  
Power supply 110-240 Vac 50/60 Hz.  
It can be in two materials: in matt black, matt white and silver plastic and in, champagne, pewter, satin gold, satin black, Ral 9003 and Ral 9010 metal zamak stainless steel.



USB A+C

DOT-SCHUKO 



Ø 7 cm  
Alimentazione 110 - 250 V ac, 50 Hz.  
Presse elettrica UK e USA su richiesta.  
Power supply 110 - 250 V ac, 50 Hz.  
UK and USA plug on demand.

DOT-USB 



USB A+C

Ø 7 cm  
Alimentazione 110 - 250 V ac, 50 Hz.  
Power supply 110 - 250 V ac, 50 Hz.

# NEFELIBATA

design STORMO STUDIO

## RIVESTIMENTI CONSIGLIATI / SUGGESTED FABRICS

<b>JAGUARD</b>	<b>BIELASTICO / BIELASTIC</b>	<b>LANA / WOOL</b>	<b>TESS. SPALMATO / COATED FABRIC</b>	<b>VELLUTO / VELVET</b>	<b>BOUCLÈ</b>	<b>PELLE / LEATHER</b>
<b>MINI MELANGE</b> Cat. lusso	<b>B-CHEW BIT</b> Cat. top	<b>FENICE</b> Cat. extra	<b>FLEXO FR</b> Cat. a	<b>LEMMING 29500</b> Cat. elegant	<b>VOLT</b> Cat. super	<b>MOON</b> Cat. extreme
<b>ONE</b> Cat. a	<b>MIRAGE</b> Cat. lusso	<b>HERO 2</b> Cat. extreme		<b>8336/8336 LT</b> Cat. lusso/extra		
<b>STEELCUT TRIO 3</b> Cat. top	<b>NAUTILUS</b> Cat. extra			<b>CINIGLIA / CHENILLE</b>		
<b>STEP</b> Cat. extra	<b>UNIFORM MELANGE</b> Cat. plus			<b>AMARA 83974</b> Cat. elegant		

Il rivestimento scelto determina il numero di cuciture necessarie. I seguenti rivestimenti bielastici garantiscono il minor numero di cuciture: Uniform Melange, B-Chew Bit, Nautilus.

The chosen upholstery determines the number of seams required. The following bi-elastic covers guarantee the least number of seams: Uniform Melange, B-Chew Bit, Nautilus.