

LIEVITO

design DEBONADEMEO STUDIO



LIEVITO cresce. Si sovrappone, si aggiunge, si connette, cuscino su cuscino, cerniera dopo cerniera. Non è un divano, non è un pouf: è un volume morbido e caldo che si stende, si alza, si impila. Prende la forma di chi lo abita e del momento in cui viene usato. Ogni configurazione è temporanea. La prossima sarà diversa.

LIEVITO grows. It layers, adds, connects — cushion upon cushion, zip after zip. It is not a sofa, not a pouf: it is a soft, warm volume that stretches out, rises, stacks up. It takes the shape of whoever inhabits it and the moment in which it is used. Every configuration is temporary. The next one will be different.

LIEVITO

design DEBONADEMEO STUDIO

MODULO BASE / BASE MODULE



COMP1



COMP2



COMP3



COMP4



LIEVITO

design DEBONADEMEO STUDIO

MODULO BASE / BASE MODULE



99 cm / 38.98"
99 cm / 38.98"
45 cm / 17.72"

 8 kg / 18 Lb

 0.50 m³

 2.75 mtl
tessuto cliente /
customer fabric
H 140 cm

 1 - 1.30 mtl
2 - 1.30 mtl

5.12 m²
pelle cliente /
customer pelle

COMP.1

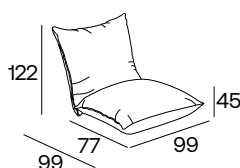

99 cm / 38.98"
99 cm / 38.98"
122 cm / 48.03"
77 cm / 30.31"
45 cm / 17.72"

 16 kg / 36 Lb

 1.31 m³

 5.40 mtl
tessuto cliente /
customer fabric
H 140 cm

 1 - 1.30 mtl
2 - 1.30 mtl
3 - 1.30 mtl
4 - 1.30 mtl

10.04 m²
pelle cliente /
customer pelle

COMP.2

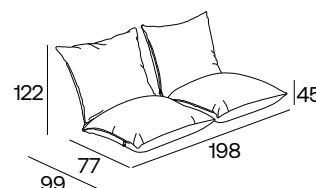

198 cm / 77.95"
99 cm / 38.98"
122 cm / 48.03"
77 cm / 30.31"
45 cm / 17.72"

 32 kg / 71 Lb

 2.57 m³

 10.30 mtl
tessuto cliente /
customer fabric
H 140 cm

 1-2-3-4-5-6-7-
8 - 1.30 mtl

19.16 m²
pelle cliente /
customer pelle

COMP.3

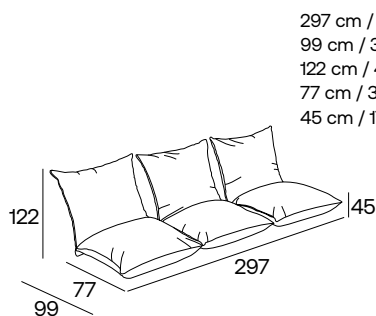

297 cm / 116.93"
99 cm / 38.98"
122 cm / 48.03"
77 cm / 30.31"
45 cm / 17.72"

 48 kg / 106 Lb

 3.83 m³

 15.02 mtl
tessuto cliente /
customer fabric
H 140 cm

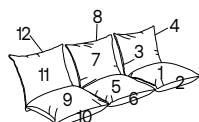

1-2-3-4-5-6-7-8-9-10-11-12
- 1.30 mtl

28.27 m²
pelle cliente /
customer pelle

COMP.4

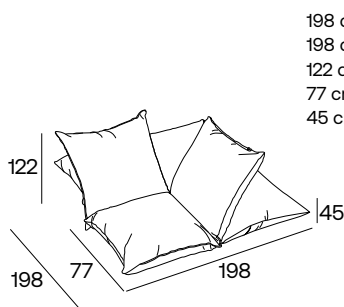

198 cm / 77.95"
198 cm / 77.95"
122 cm / 48.03"
77 cm / 30.31"
45 cm / 17.72"

 48 kg / 106 Lb

 5.06 m³

 15.02 mtl
tessuto cliente /
customer fabric
H 140 cm

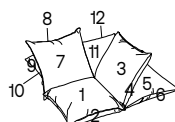

1-2-3-4-5-6-7-8-9-10-11-12
- 1.30 mtl

28.27 m²
pelle cliente /
customer pelle

LIEVITO

design DEBONADEMEO STUDIO

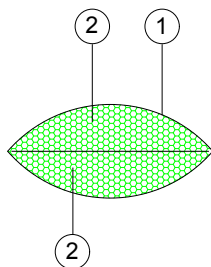

MATERIALI / MATERIALS

1 - tessuto/pelle

2 - sfere di polistirolo a dimensione variabile e trucioli di poliuretano a diverse densità, derivati dal recupero di residui produttivi

1 - fabric/leather

2 - filling made of variable-size polystyrene beads and polyurethane foam flakes in different densities, both derived from recovered production remnants

CARATTERISTICHE / TECHNICAL FEATURES

SFODERABILITÀ / COVER REMOVAL



VARIANTI / VERSIONS



CERNIERA / ZIPPER

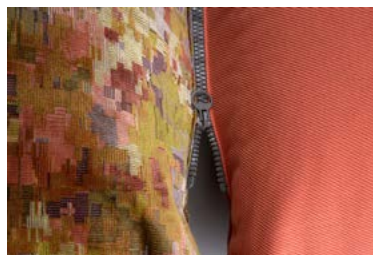

I singoli moduli si uniscono tra loro tramite cerniera. The units can be joined together with a zipper.

RIVESTIMENTI CONSIGLIATI / SUGGESTED FABRICS

JAUQUARD	BIELASTICO / BIELASTIC	LANA / WOOL	TESS. SPALMATO / COATED FABRIC	VELLUTO / VELVET	MICROFIBRA/ MICROFIBER	BOUCLÉ	PELLE / LEATHER
CHILI Cat. extra	B-CHEW BIT Cat. top	EUROPOST 2 Cat. elegant	VINTAGE Cat. extra	LEMMING 29500 Cat. elegant	MYSTIQUE Cat. extra	VOLT Cat. super	MOON Cat. extreme
MINI MELANGE Cat. lusso	MIRAGE Cat. lusso	FENICE Cat. extra	FLEXO FR Cat. a	8336/8336 LT Cat. lusso/extra			FLOWER Cat. elegant
OCEANIC Cat. elegant	NAUTILUS Cat. extra	HERO 2 Cat. extreme	ZEUS Cat. a	CINIGLIA / CHENILLE AMARA 83974 Cat. elegant			BASIC Cat. elegant
ONE Cat. a	UNIFORM MELANGE Cat. plus						
PANAREA OUTDOOR Cat. a							
RADIO Cat. a							
STEELCUT TRIO 3 Cat. top							
STEP Cat. extra							
SUMMER/SUMMER FR Cat. a							