

DROP

design GAE AVITABILE



Una goccia che si posa. Il volume orizzontale, lo schienale organico che lo attraversa: un gesto elementare e poetico tradotto in sistema di sedute. DROP sceglie la chiarezza formale come manifesto. Le sedute si accostano, si specchiano, gli schienali si toccano e creano una continuità silenziosa. La semplicità più radicale diventa il linguaggio di uno spazio che sa ascoltare..

A drop that settles. The horizontal volume, the organic backrest crossing through it: an elemental and poetic gesture translated into a seating system. DROP chooses formal clarity as its manifesto. Seats come together, mirror each other, backrests meet and touch, generating a continuity of form and matter that transforms the single piece into a landscape. The most radical simplicity, taken all the way.

DROP
design GAE AVITABILE

1P / 1S



2P / 2S



3P / 3S



DROP

design GAE AVITABILE

1P / 1S

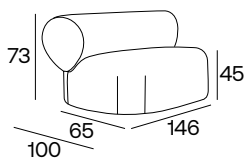

146 cm / 57.48"
100 cm / 39.37"
73 cm / 28.74"
45 cm / 17.72"
65 cm / 25.59"

 35 kg / 78 Lb

 1.17 m³

 **5.60 mtl**
tessuto cliente /
customer fabric
H 140 cm

10.42 m²
pelle cliente /
customer pelle

2P / 2S

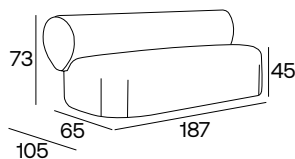

187 cm / 73.62"
105 cm / 41.34"
73 cm / 28.74"
45 cm / 17.72"
65 cm / 25.59"

 45 kg / 100 Lb

 1.56 m³

 **7.10 mtl**
tessuto cliente /
customer fabric
H 140 cm

13.21 m²
pelle cliente /
customer pelle

3P / 3S

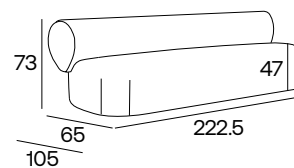

222.5 cm / 87.60"
105 cm / 41.34"
73 cm / 28.74"
47 cm / 18.50"
65 cm / 25.59"

 54 kg / 120 Lb

 1.86 m³

 **8.60 mtl**
tessuto cliente /
customer fabric
H 140 cm

15.07 m²
pelle cliente /
customer pelle

DROP

design GAE AVITABILE

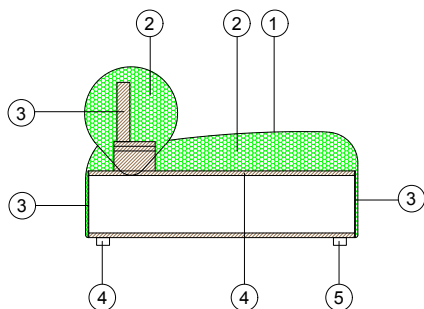

MATERIALI / MATERIALS

1 - tessuto/pelle

2 - poliuretano espanso indeformabile di diverse densità e strato di fibra di dacron® 100 gr

3 - telaio in agglomerato di legno

4 - cinghie elastiche intrecciate

5 - piedi P 59

1 - fabric/leather

2 - high resilience polyurethane foam of different densities and dacron® fiber 100 gr layer

3 - structural frame in plywood

4 - elastic webbing

5 - feet P 59

PIEDI / FEET



P 59 h 2,5 cm
Piedi in legno
verniciato nero
Black varnished feet

CARATTERISTICHE / TECHNICAL FEATURES

SFODERABILITÀ /
COVER REMOVAL



VARIANTI / VERSIONS



RIVESTIMENTI CONSIGLIATI / SUGGESTED FABRICS

JAQUARD

CHILI
Cat. extra

MINI MELANGE
Cat. lusso

OCEANIC
Cat. elegant

ONE
Cat. a

RADIO
Cat. a

STEELCUT TRIO 3
Cat. top

STEP
Cat. extra

BIELASTICO / BIELASTIC

B-CHEW BIT
Cat. top

MIRAGE
Cat. lusso

NAUTILUS
Cat. extra

UNIFORM MELANGE
Cat. plus

LANA / WOOL

EUROPOST 2
Cat. elegant

FENICE
Cat. extra

HERO 2
Cat. extreme

TESS. SPALMATO / COATED FABRIC

FLEXO FR
Cat. a

ZEUS
Cat. a

VELLUTO / VELVET

LEMMING 29500
Cat. elegant

8336/8336 LT
Cat. lusso/extra

CINIGLIA /
CHENILLE

AMARA 83974
Cat. elegant

BOUCLÈ

VOLT
Cat. super

PELLE / LEATHER

MOON
Cat. extreme

FLOWER
Cat. elegant

BASIC
Cat. elegant