

SLY

design ITALO PERTICHINI



Curve piene e forma avvolgente sono i tratti principali delle sedute SLY, la collezione delle “finestre magiche” chiuse con corde colorate intrecciate, fessure che si aprono sul mondo esterno, ma che conservano discrezione e riservatezza spezzando con le loro curve il rigore degli schienali.

The full curves and wraparound form define the design of SLY, the collection with the “magic windows” – cracks that open to the outside world, but that retain discretion and privacy, tied with colored strings that break the severity of the backrest outline with their lacing.

SLY

design ITALO PERTICHINI

LOW 1P / 1S



LOW 2P / 2S



HIGH 1P / 1S



HIGH 2P / 2S



SLY

design ITALO PERTICHINI

LOW 1P / 1S

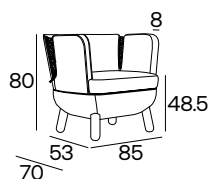

85 cm / 33.46"
70 cm / 27.56"
80 cm / 31.50"
48.5 cm / 19.09"
53 cm / 20.87"
8 cm / 3.15"

 23 kg / 51 Lb

 0.54 m³

 5.50 mtl
tessuto cliente /
customer fabric
H 140 cm

10.23 mtl
pelle cliente /
customer leather

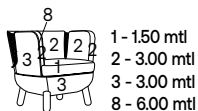

LOW 2P / 2S

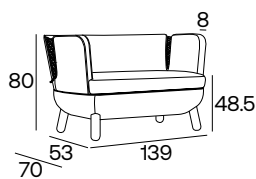

139 cm / 54.72"
70 cm / 27.56"
80 cm / 31.50"
48.5 cm / 19.09"
53 cm / 20.87"
8 cm / 3.15"

 34 kg / 122 Lb

 0.87 m³

 7.50 mtl
tessuto cliente /
customer fabric
H 140 cm

13.95 mtl
pelle cliente /
customer leather

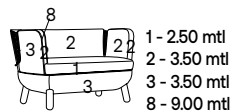

HIGH 1P / 1S

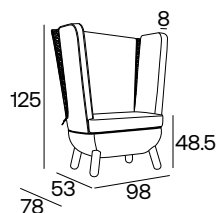

98 cm / 38.58"
78 cm / 30.71"
125 cm / 49.21"
48.5 cm / 19.09"
53 cm / 20.87"
8 cm / 3.15"

 37 kg / 82 Lb

 1.05 m³

 7.00 mtl
tessuto cliente /
customer fabric
H 140 cm

13.02 mtl
pelle cliente /
customer leather

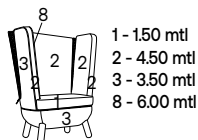

HIGH 2P / 2S

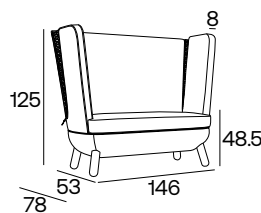

146 cm / 57.48"
78 cm / 30.71"
125 cm / 49.21"
48.5 cm / 19.09"
53 cm / 20.87"
8 cm / 3.15"

 48 kg / 106 Lb

 1.55 m³

 10.00 mtl
tessuto cliente /
customer fabric
H 140 cm

18.60 mtl
pelle cliente /
customer leather

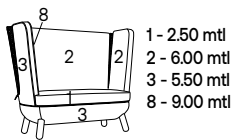

SLY

design ITALO PERTICHINI

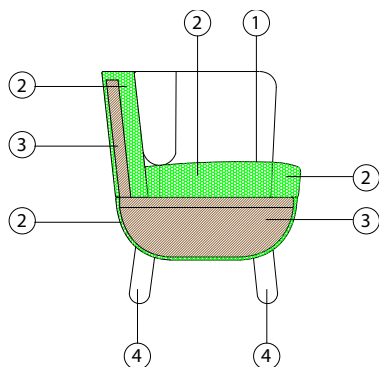

MATERIALI / MATERIALS

1 - tessuto/pelle

2 - poliuretano espanso indeformabile di diverse densità e strato di fibra di dacron® 100 gr

3 - telaio in multistrato di legno

4 - piedi P 58

1 - fabric/leather

2 - high resilience polyurethane foam of different densities and dacron® fiber 100 gr layer

3 - structural frame in plywood

4 - feet P 58

PIEDI / FEET



P 58 h 15 cm
Piedi in legno di faggio naturale
Natural beechwood feet

DI SERIE / INCLUDED



01
Naturale
Natural

OPTIONAL / EXTRA COST

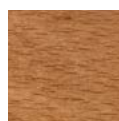

04
Noce chiaro
Light walnut

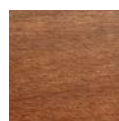

05
Noce
Walnut



07/20
Nero
Black

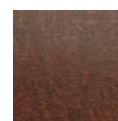

10
Wengè



RAL - NCS a scelta
RAL - NCS on request

CORDINO / STRING



Arancio
Orange

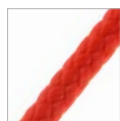

Rosso
Red



Viola
Purple



Blu
Blue



Verde scuro
Dark green



Verde chiaro
Light green



Grigio
Grey



Nero
Black

CARATTERISTICHE / TECHNICAL FEATURES

SFODERABILITÀ /
COVER REMOVAL



VARIANTI / VERSIONS



SLY

design ITALO PERTICHINI

RIVESTIMENTI CONSIGLIATI / SUGGESTED FABRICS

JAGUARD	BIELASTICO / BIELASTIC	LANA / WOOL	TESS. SPALMATO / COATED FABRIC	VELLUTO / VELVET	MICROFIBRA/ MICROFIBER	BOUCLÈ	PELLE / LEATHER
CHILI Cat. extra	B-CHEW BIT Cat. top	EUROPOST 2 Cat. elegant	VINTAGE Cat. extra	LEMMING 29500 Cat. elegant	MYSTIQUE Cat. extra	VOLT Cat. super	MOON Cat. extreme
MINI MELANGE Cat. lusso	MIRAGE Cat. lusso	FENICE Cat. extra	FLEXO FR Cat. a	8336/8336 LT Cat. lusso/extra			
OCEANIC Cat. elegant	NAUTILUS Cat. extra	HERO 2 Cat. extreme	ZEUS Cat. a	CINIGLIA / CHENILLE			
ONE Cat. a	UNIFORM MELANGE Cat. plus			AMARA Cat. elegant			
PANAREA OUTDOOR Cat. a							
RADIO Cat. a							
STEELCUT TRIO 3 Cat. top							
STEP Cat. extra							
SUMMER/SUMMER FR Cat. a							