

NUDA

design SIMONE MICHELI



NUDA è la celebrazione dell'essenzialità delle forme. Libera da qualsiasi ornamento, trasforma la complessità del nostro tempo in semplicità; mette a nudo le sue linee e richiama a una purezza formale senza compromessi.

NUDA is the celebration of shape in its essence. Stripped bare of any decoration, NUDA turns the complexity of our times into simplicity and claims an uncompromising formal purity.

NUDA

design SIMONE MICHELI

1P / 1S



2P / 2S



3P / 3S



CHAISELONGUE



POUF



NUDA

design SIMONE MICHELI

1P / 1S

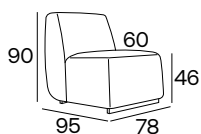

78 cm / 30.71"
95 cm / 37.40"
90 cm / 35.43"
46 cm / 18.11"
60 cm / 23.62"

 **34 kg / 75 Lb**

 **0.74 m³**

 **3.80 mtl**
tessuto cliente /
customer fabric
H 140 cm

7.07 m²
pelle cliente /
customer pelle

2P / 2S

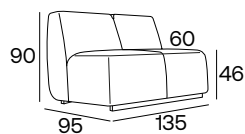

135 cm / 53.15"
95 cm / 37.40"
90 cm / 35.43"
46 cm / 18.11"
60 cm / 23.62"

 **48 kg / 106 Lb**

 **1.26 m³**

 **6.00 mtl**
tessuto cliente /
customer fabric
H 140 cm

11.16 m²
pelle cliente /
customer pelle

3P / 3S

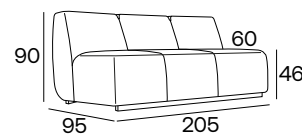

205 cm / 80.71"
95 cm / 37.40"
90 cm / 35.43"
46 cm / 18.11"
60 cm / 23.62"

 **56 kg / 124 Lb**

 **1.90 m³**

 **8.50 mtl**
tessuto cliente /
customer fabric
H 140 cm

15.81 m²
pelle cliente /
customer pelle

CHAISELONGUE

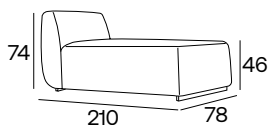

78 cm / 30.71"
210 cm / 82.68"
74 cm / 29.13"
46 cm / 18.11"

 **54 kg / 120 Lb**

 **1.33 m³**

 **6.00 mtl**
tessuto cliente /
customer fabric
H 140 cm

11.16 m²
pelle cliente /
customer pelle

POUF

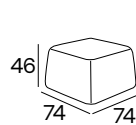

74 cm / 29.13"
74 cm / 29.13"
46 cm / 18.11"

 **15 kg / 34 Lb**

 **0.30 m³**

 **3.10 mtl**
tessuto cliente /
customer fabric
H 140 cm

5.77 m²
pelle cliente /
customer pelle

NUDA

design SIMONE MICHELI

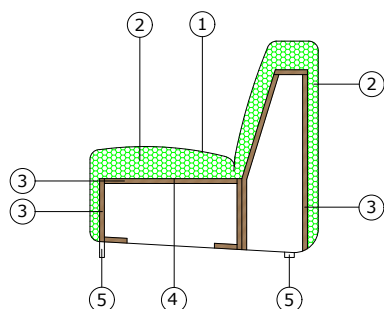

MATERIALI / MATERIALS

- 1 - tessuto/pelle
- 2 - poliuretano espanso indeformabile di diverse densità e strato di fibra di dacron® 100 gr
- 3 - telaio in agglomerato di legno
- 4 - cinghie elastiche intrecciate
- 5 - strutture P 104-piedi P 59

- 1 - fabric/leather
- 2 - high resilience polyurethane foam of different densities and dacron® fiber 100 gr layer
- 3 - structural frame in plywood
- 4 - elastic webbing
- 5 - frame P 104-feet P 59

PIEDI / FEET



P 104 h 6/2 cm
Struttura in legno
verniciato nero
Black varnished frame



P 59 h 2,5 cm
Piedi in legno
verniciato nero
Black varnished feet

CARATTERISTICHE / TECHNICAL FEATURES

SFODERABILITÀ /
COVER REMOVAL



VARIANTI / VERSIONS



RIVESTIMENTI CONSIGLIATI / SUGGESTED FABRICS

JAQUARD	BIELASTICO / BIELASTIC	LANA / WOOL	TESS. SPALMATO / COATED FABRIC	VELLUTO / VELVET	MICROFIBRA/ MICROFIBER	BOUCLÉ	PELLE / LEATHER
CHILI Cat. extra	B-CHEW BIT Cat. top	EUROPOST 2 Cat. elegant	VINTAGE Cat. extra	LEMMING 29500 Cat. elegant	MYSTIQUE Cat. extra	VOLT Cat. super	MOON Cat. extreme
MINI MELANGE Cat. lusso	MIRAGE Cat. lusso	FENICE Cat. extra	FLEXO FR Cat. a	8336/8336 LT Cat. lusso/extra			FLOWER Cat. elegant
OCEANIC Cat. elegant	NAUTILUS Cat. extra	HERO 2 Cat. extreme	ZEUS Cat. a	CINIGLIA / CHENILLE			BASIC Cat. elegant
ONE Cat. a	UNIFORM MELANGE Cat. plus			AMARA 83974 Cat. elegant			
PANAREA OUTDOOR Cat. a							
RADIO Cat. a							
STEELCUT TRIO 3 Cat. top							
STEP Cat. extra							
SUMMER/SUMMER FR Cat. a							