

# BIXIB

design LUCA ALESSANDRINI

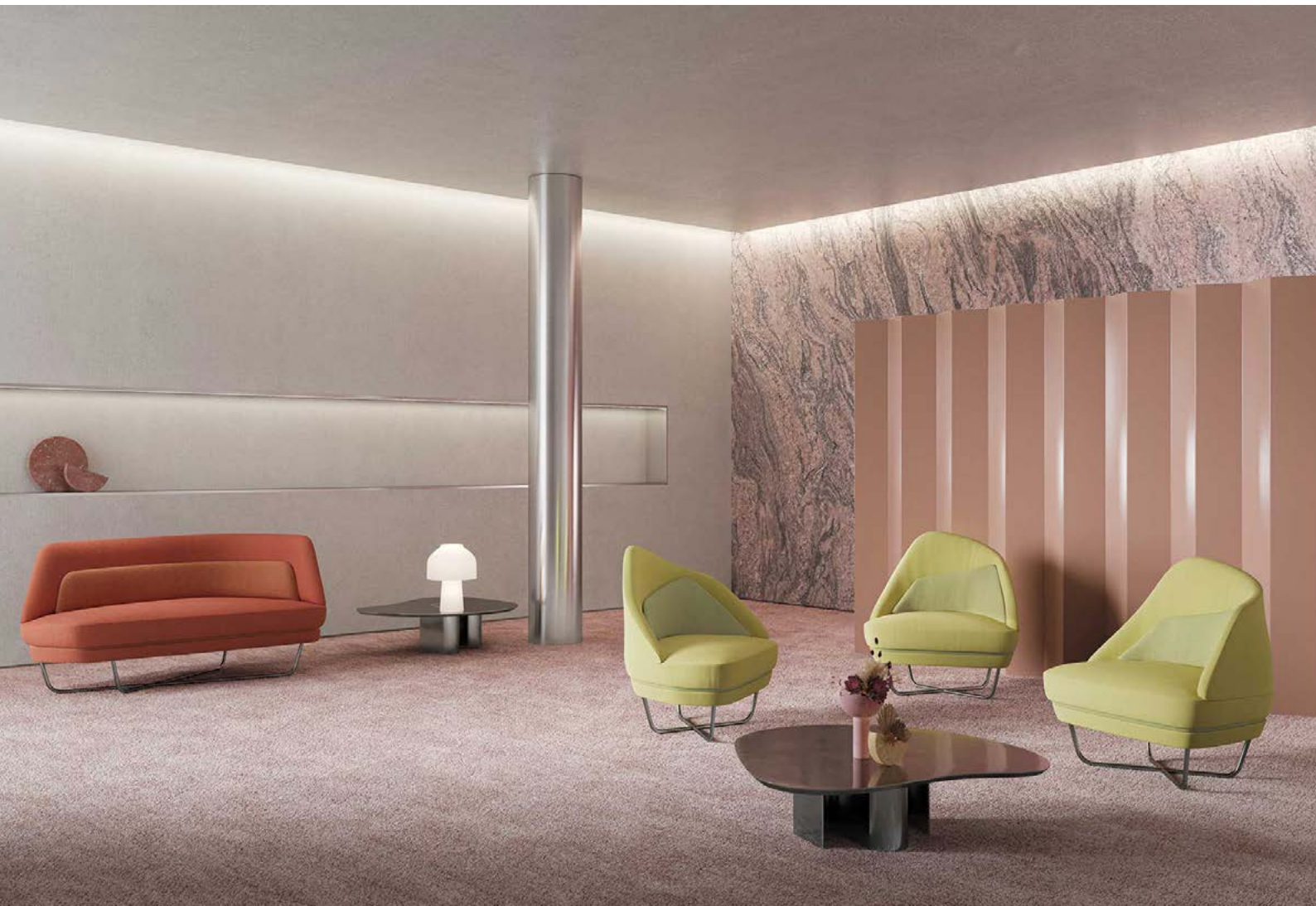

BIXIB è liberamente ispirato al nome latino del baco da seta Bombyx Mori. Sedute che cambiano forma in base alla prospettiva dalle quali le si osserva: quel che frontalmente è simmetrico diventa liberamente organico al variare dell'angolazione.

BIXIB freely refers to the Latin name of the silkworm Bombyx Mori. BIXIB is a geometry of upholstered artefacts that change according to the perspective from which you observe them: what is symmetrical from the front becomes freely organic as the observation angle changes.

# BIXIB

design LUCA ALESSANDRINI

1P / 1S



2P / 2S



# BIXIB

design LUCA ALESSANDRINI

## 1P / 1S

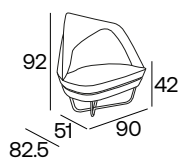

90 cm / 35.43"  
82.5 cm / 32.48"  
92 cm / 36.22"  
42 cm / 16.54"  
51 cm / 20.08"

 35 kg / 78 Lb

 0.76 m<sup>3</sup>

 5.00 mtl  
tessuto cliente /  
customer fabric  
H 140 cm

9.30 m<sup>2</sup>  
pelle cliente /  
customer leather



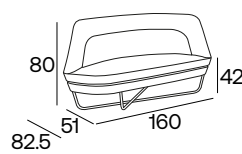

1 - 4.50 mtl  
2 - 1.50 mtl  
5 - 3.00 mtl  
13 - 3.00 mtl

## 2P / 2S



160 cm / 62.99"  
82.5 cm / 32.48"  
80 cm / 31.50"  
42 cm / 16.54"  
51 cm / 20.08"

 55 kg / 122 Lb

 1.16 m<sup>3</sup>

 6.50 mtl  
tessuto cliente /  
customer fabric  
H 140 cm

12.09 m<sup>2</sup>  
pelle cliente /  
customer leather

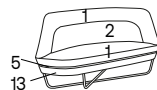

1 - 6.50 mtl  
2 - 2.00 mtl  
5 - 4.50 mtl  
13 - 4.50 mtl

# BIXIB

design LUCA ALESSANDRINI

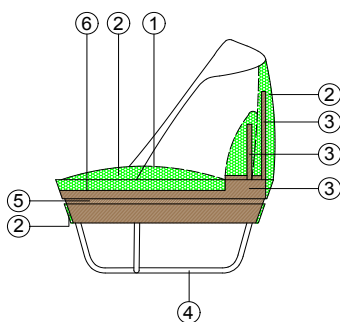

## MATERIALI / MATERIALS

- 1 - tessuto/pelle
- 2 - poliuretano espanso indeformabile di diverse densità e strato di fibra di dacron® 100 gr
- 3 - telaio in multiflex e multistrato di legno
- 4 - struttura B 43
- 5 - telaio in multistrato di legno
- 6 - cinghie elastiche intrecciate

- 1 - fabric/leather
- 2 - high resilience polyurethane foam of different densities and dacron® fiber 100 gr layer
- 3 - structural frame in plywood and multiflex wood
- 4 - frame B 43
- 5 - structural frame in plywood
- 6 - elastic webbing

## PIEDI / FEET



B 43 Ø 2 cm h 20 cm  
Struttura tubolare  
metallo verniciato a  
sezione tonda  
Circular varnished  
tubular metal frame



RAL - NCS a scelta  
RAL - NCS on  
request

## CARATTERISTICHE / TECHNICAL FEATURES

SFODERABILITÀ /  
COVER REMOVAL



VARIANTI / VERSIONS



## RIVESTIMENTI CONSIGLIATI / SUGGESTED FABRICS

JAGUARD	BIELASTICO / BIELASTIC	LANA / WOOL	TESS. SPALMATO / COATED FABRIC	VELLUTO / VELVET	MICROFIBRA/ MICROFIBER	BOUCLÈ	PELLE / LEATHER
CHILI Cat. extra	B-CHEW BIT Cat. top	EUROPOST 2 Cat. elegant	VINTAGE Cat. extra	LEMMING 29500 Cat. elegant	MYSTIQUE Cat. extra	VOLT Cat. super	MOON Cat. extreme
MINI MELANGE Cat. lusso	MIRAGE Cat. lusso	FENICE Cat. extra	FLEXO FR Cat. a	8336/8336 LT Cat. lusso/extra			
OCEANIC Cat. elegant	NAUTILUS Cat. extra	HERO 2 Cat. extreme	ZEUS Cat. a	CINIGLIA / CHENILLE			
ONE Cat. a	UNIFORM MELANGE Cat. plus			AMARA 83974 Cat. elegant			
PANAREA OUTDOOR Cat. a							
RADIO Cat. a							
STEELCUT TRIO 3 Cat. top							
STEP Cat. extra							
SUMMER/SUMMER FR Cat. a							